

BR-2330

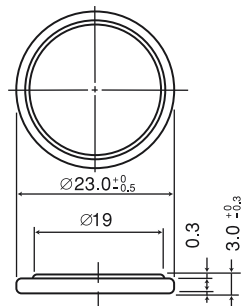

SPECIFICATIONS

Name	BR-2330
Nominal voltage (V)	3
Nominal capacity (mAh)	255
Continuous drain (mA)	0.03
Operating temperature (°C)	-30 to +80
Weight (g)	3.0

DISCHARGE TEMPERATURE CHARACTERISTICS

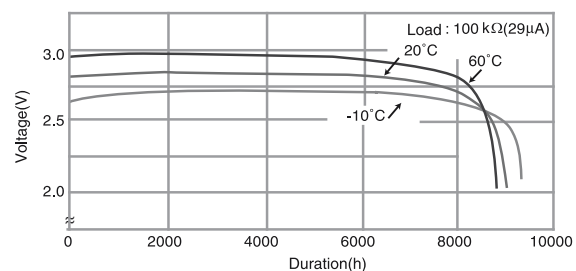

OPERATING VOLTAGE VS. DISCHARGE CURRENT*

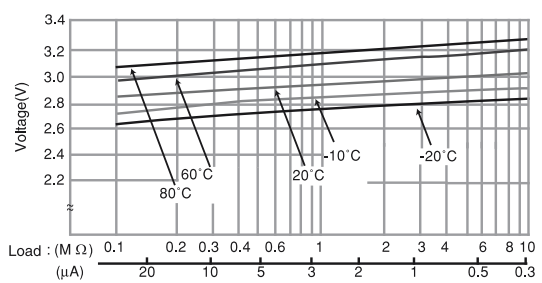

CAPACITY VS. LOAD RESISTANCE

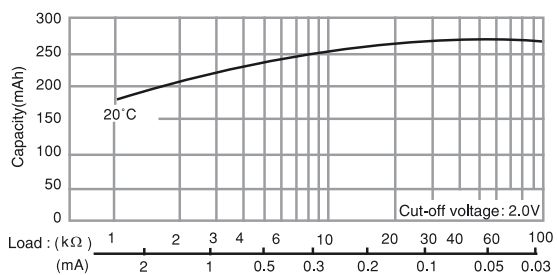

BR-3032

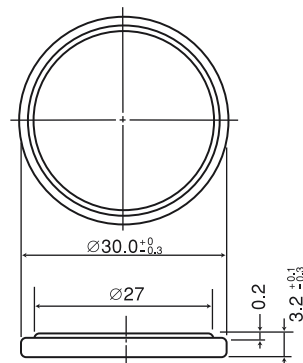

SPECIFICATIONS

Name	BR-3032
Nominal voltage (V)	3
Nominal capacity (mAh)	500
Continuous drain (mA)	0.03
Operating temperature (°C)	-30 to +80
Weight (g)	5.5

DISCHARGE TEMPERATURE CHARACTERISTICS

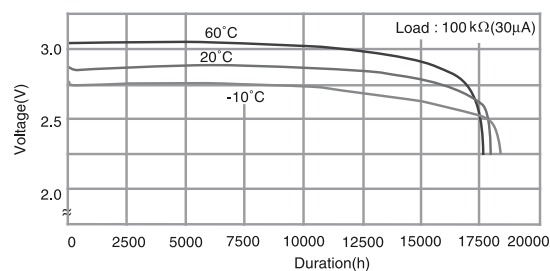

OPERATING VOLTAGE VS. DISCHARGE CURRENT*

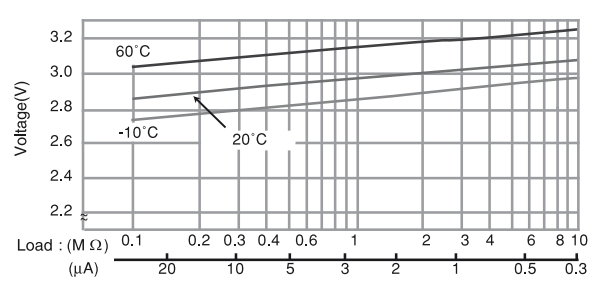

CAPACITY VS. LOAD RESISTANCE

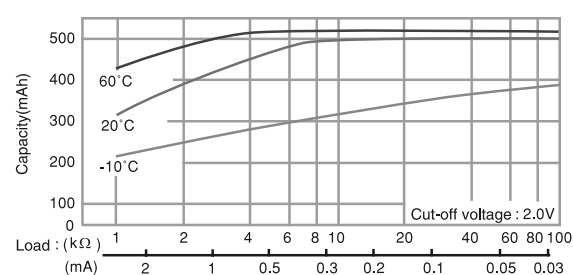

The data in this document are for descriptive purposes only and are not intended to make or imply any guarantee or warranty.

* Voltage at 50% discharge depth.