

BR-425

DIMENSIONS (MM)

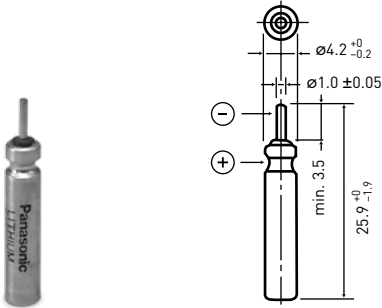

Model number	BR-425
Nominal voltage (V)	3
Nominal capacity (mAh)	25
Diameter (mm)	4.2
Total height (mm)	25.9
Discharging temperature range (°C)	-30 to +80
Weight (g)	0.6

DISCHARGE TEMPERATURE CHARACTERISTICS

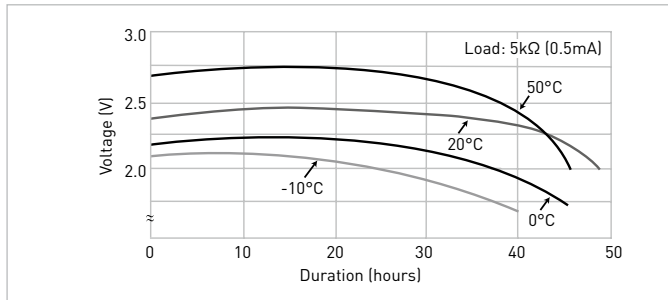

OPERATING VOLTAGE VS. DISCHARGE CURRENT*1

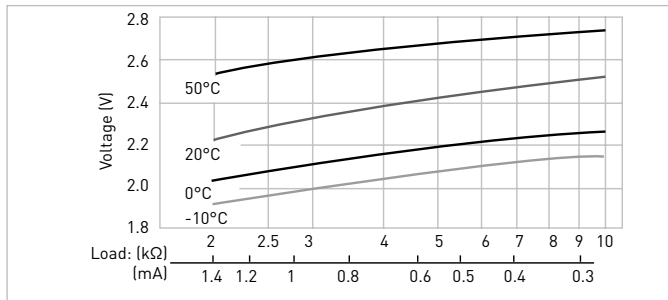

CAPACITY VS. LOAD RESISTANCE

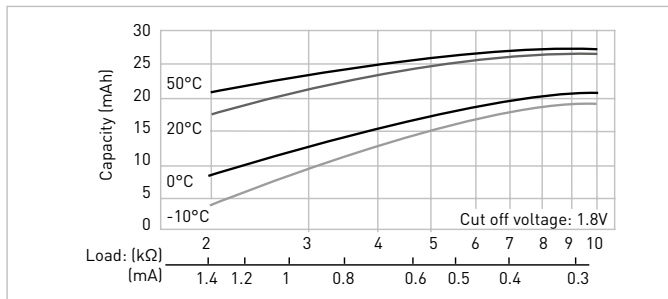

BR-435

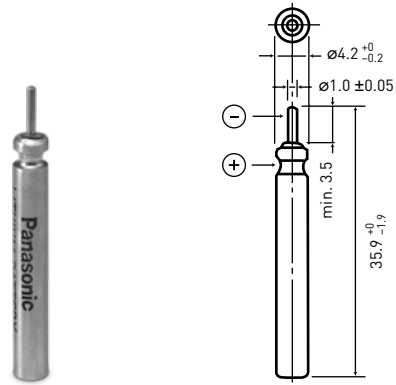

Model number	BR-435
Nominal voltage (V)	3
Nominal capacity (mAh)	50
Diameter (mm)	4.2
Total height (mm)	35.9
Discharging temperature range (°C)	-30 to +80
Weight (g)	0.9

DISCHARGE TEMPERATURE CHARACTERISTICS

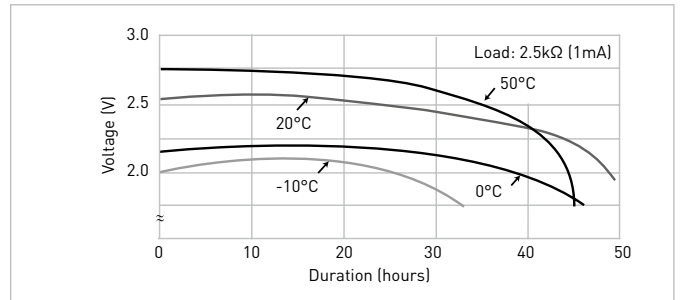

OPERATING VOLTAGE VS. DISCHARGE CURRENT*1

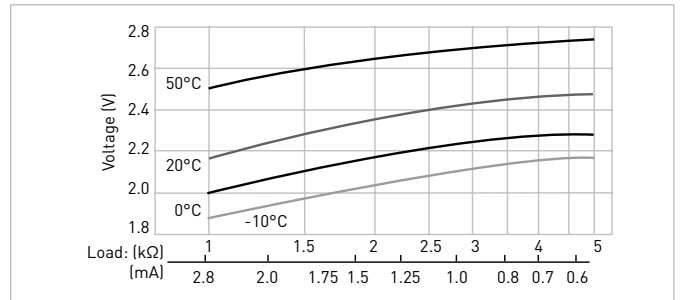

CAPACITY VS. LOAD RESISTANCE

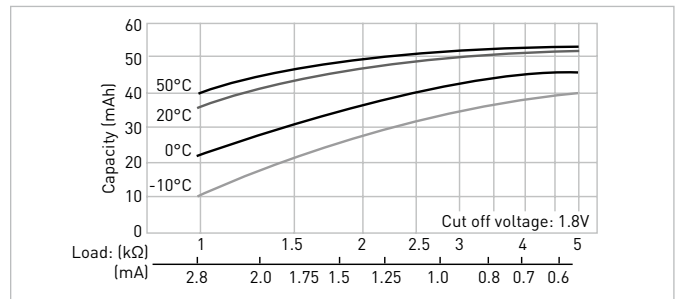

The data in this document are for descriptive purposes only and are not intended to make or imply any guarantee or warranty.

*1 Voltage at 50% discharge depth.