

LC-P123R4P

DIMENSIONS (MM)

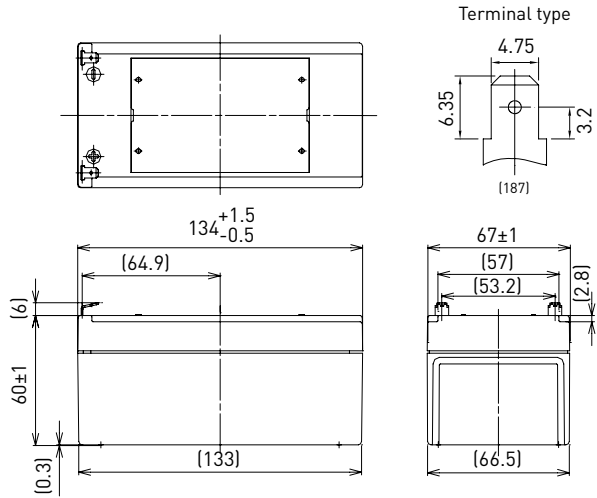

FOR STANDBY POWER SUPPLIES.
 EXPECTED TRICKLE DESIGN LIFE: 10 - 12 YEARS AT 20°C
 ACCORDING TO EUROBAT.



Contents indicated (including the recycle marking, etc.) are subject to change without notice.

Battery case resin: flame retardant (UL94 V-0)

SPECIFICATIONS		LC-P123R4P
Name	LC-P123R4P	
Nominal voltage	12V	
Nominal capacity (20 hour rate)	3.4Ah	
Dimensions	Length	134mm
	Width	67mm
	Height	66mm
Approx. mass	1.15kg	
Terminal	Faston 187	
Capacity (25°C)	20 hour rate	3.4Ah
	10 hour rate	3.1Ah
	3 hour rate	2.8Ah
	1 hour rate	2.3Ah
Impedance	Fully charged battery (25°C)	50mΩ
Temperature dependency of capacity (20 hour rate)	40°C	102%
	25°C	100%
	0°C	85%
	-15°C	65%
Self-discharge (25°C)	After 3 month	91%
	After 6 month	82%
	After 12 month	64%

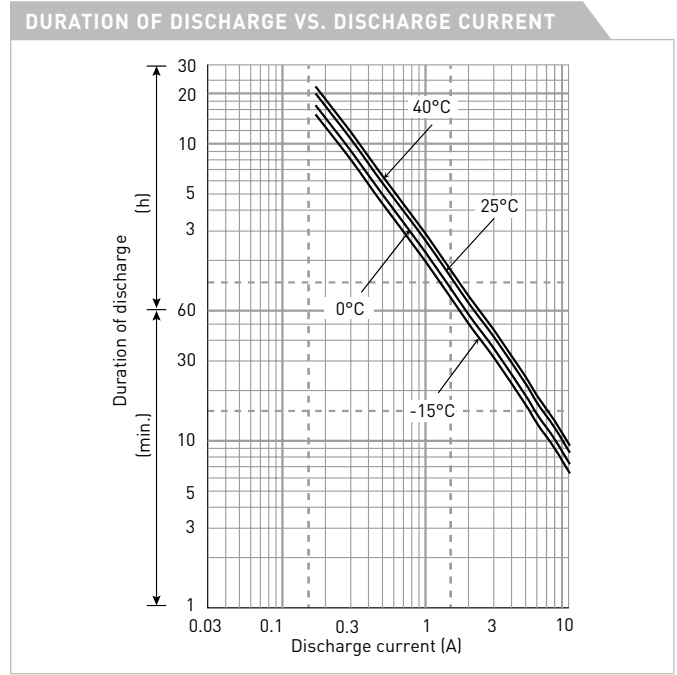

WATT TABLE (25°C)																(Wattage/battery)
Cut-off	3min.	5min.	10min.	15min.	20min.	30min.	45min.	1h	1.5h	2h	3h	4h	5h	6h	10h	20h
9.6V	204	161	105	80.4	67.4	50.3	35.5	28.4	19.6	15.0	11.3	8.63	7.13	5.80	3.81	2.06
9.9V	190	151	103	79.8	66.3	49.7	35.3	28.4	19.2	14.9	11.2	8.58	7.07	5.78	3.80	2.05
10.2V	175	142	100	78.2	65.2	49.2	34.9	27.8	18.8	14.5	11.1	8.52	7.01	5.73	3.76	2.05
10.5V	155	127	93	72.8	61.9	48.1	34.4	27.3	18.4	14.0	11.0	8.46	6.96	5.66	3.74	2.04
10.8V	131	112	83	67.9	60.3	46.4	33.8	26.7	17.8	13.4	10.7	8.46	6.79	5.66	3.68	1.98

AMPERE TABLE (25°C)																(Ampere/battery)
Cut-off	3min.	5min.	10min.	15min.	20min.	30min.	45min.	1h	1.5h	2h	3h	4h	5h	6h	10h	20h
9.6V	18.4	14.4	9.40	6.99	5.81	4.30	3.02	2.41	1.66	1.26	0.949	0.722	0.595	0.484	0.318	0.171
9.9V	17.0	13.6	9.21	6.94	5.71	4.25	3.00	2.41	1.62	1.26	0.945	0.718	0.590	0.482	0.316	0.171
10.2V	15.7	12.7	8.97	6.80	5.62	4.20	2.97	2.36	1.59	1.22	0.935	0.713	0.586	0.478	0.313	0.170
10.5V	14.0	11.4	8.31	6.33	5.34	4.11	2.93	2.31	1.56	1.18	0.921	0.708	0.581	0.472	0.312	0.170
10.8V	11.8	10.1	7.41	5.90	5.19	3.97	2.88	2.27	1.51	1.13	0.897	0.708	0.567	0.472	0.307	0.165

All mentioned values are average values

LC-P123R4P

CHARGING METHOD (25°C)

Trickle use Control voltage: 13.6V - 13.8V
Initial current: 0.51A or smaller

CUT-OFF VOLTAGE

Discharge current	0.17A - 0.68A	0.68A - 1.7A	1.7A - 3.4A	3.4A - 6.8A	6.8A - 10.2A
Cut-off voltage	10.5V	10.2V	9.9V	9.3V	8.7V

INFLUENCE OF TEMPERATURE ON TRICKLE LIFE

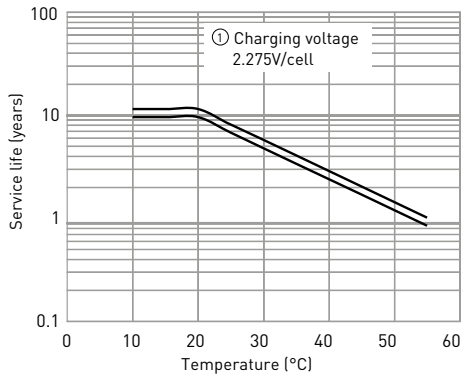

RESIDUAL CAPACITY VS. STORAGE PERIOD

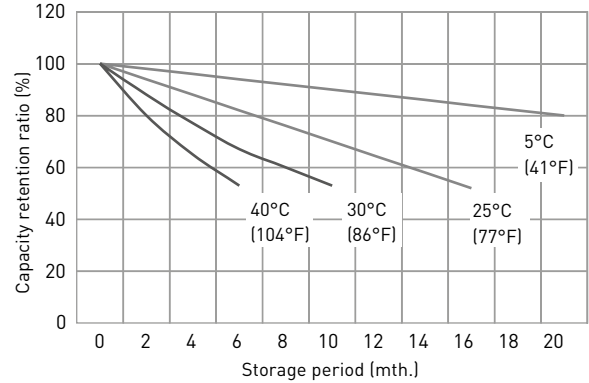

CONSTANT-VOLTAGE CONSTANT-CURRENT CHARGE CHARACTERISTICS FOR TRICKLE USE

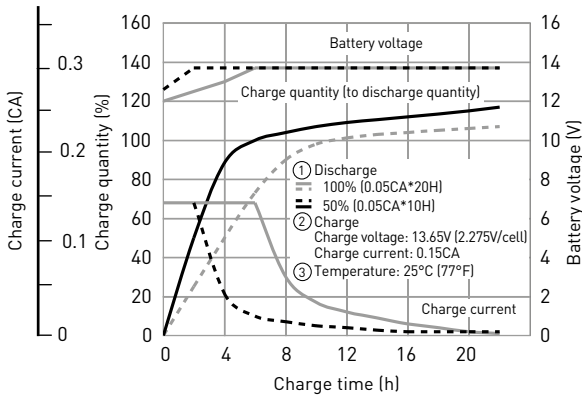

DISCHARGE CAPACITY BY TEMPERATURE AND BY DISCHARGE CURRENT

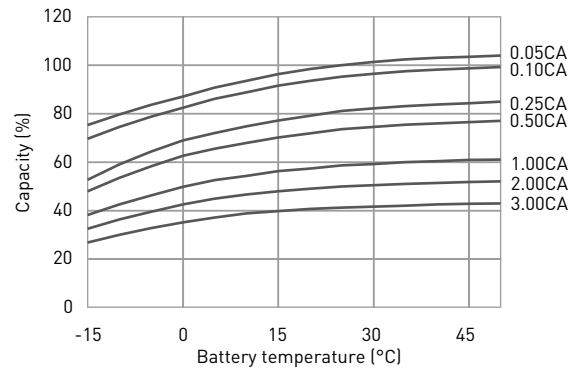

DISCHARGE CHARACTERISTICS

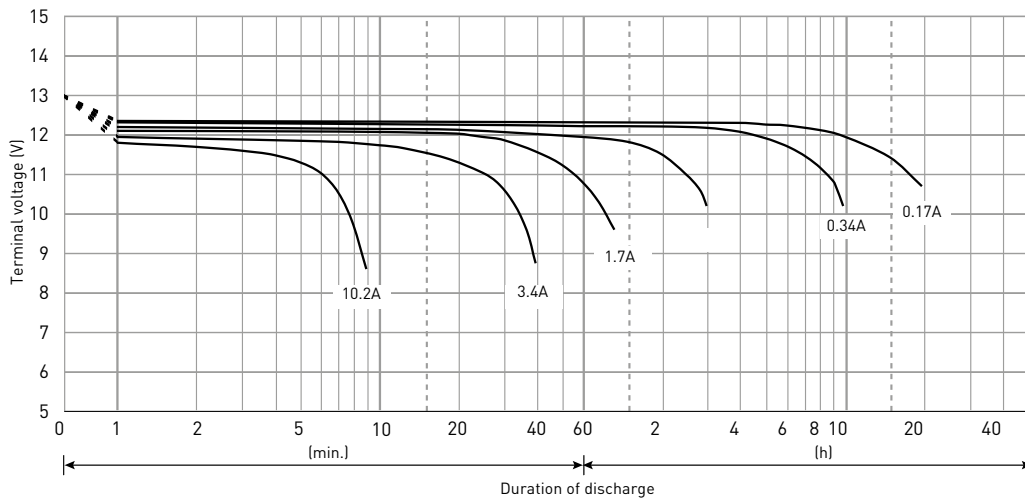

The data in this document are for descriptive purposes only and are not intended to make or imply any guarantee or warranty. Regarding handling and safety please consult our VRLA technical handbook chapter 1.