

Panasonic

Lithium Ion NCA463436A

Features & Benefits

- High energy density
- Long stable power and long run time
- Ideal for portable communications, portable computing, DSC and Camcorder.

* At temperatures below 10°C, charge at a 0.35C rate.

Specifications

Rated capacity ⁽¹⁾	Min. 680mAh
Capacity ⁽²⁾	Min. 695mAh Typ. 720mAh
Nominal voltage	3.6V
Charging	CC-CV, Std. 487mA, 4.20V, 4.0 hrs
Weight (max.)	12.4 g
Temperature	Charge*: 0 to +45°C Discharge: -20 to +60°C Storage: -20 to +50°C
Energy density	Volumetric: 437 Wh/l Gravimetric: 197 Wh/kg

⁽¹⁾ At 20°C ⁽²⁾ At 25°C

Dimensions

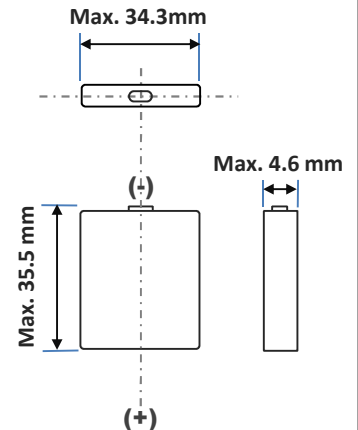

For Reference Only

Charge Characteristics

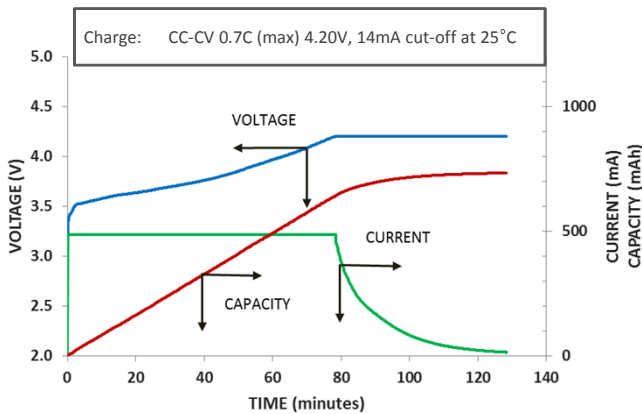

Cycle Life Characteristics

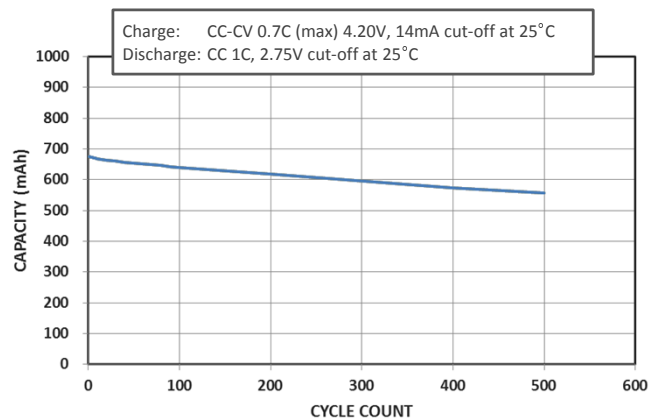

Discharge Characteristics (by temperature)

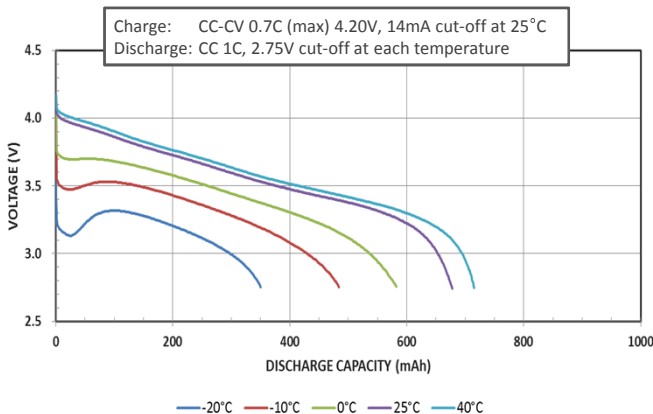

Discharge Characteristics (by rate of discharge)

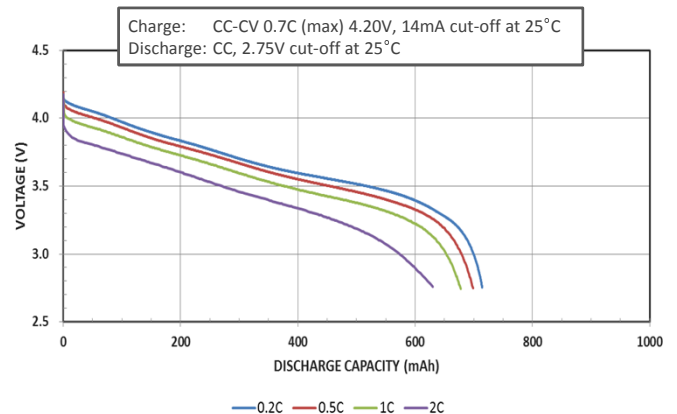

The data in this document is for descriptive purposes only and is not intended to make or imply any guarantee or warranty.